







PRODUCTOS ADSL PRODUCTS



ADSL Splitters	Ref.	Description
	SAP001	ADSL Splitter POTS/600/4KHz
	SAP020	ADSL Splitter POTS/600/16kHz
	SAP100	ADSL Splitter POTS/ZC1/4KHz
	SAP120	ADSL Splitter POTS/ZC1/16KHz
	SAI001	ADSL Splitter RDSI/2B1Q-135
	SAI002	ADSL Splitter RDSI/4B3T-150
	SAC001	ADSL Splitter Combi/ZC1+2B1Q-135
	SAC002	ADSL Splitter Combi/ZC3+4B3T-150
	SAC003	ADSL Splitter Combi/600+2B1Q-135
ST ADSL Splitters	Ref.	Description
	SAP001 ST	ADSL Splitter POTS/600/4KHz/ST
	SAP020 ST	ADSL Splitter POTS/600/16kHz/ST
	SAP100 ST	ADSL Splitter POTS/ZC1/4KHz/ST
	SAP120 ST	ADSL Splitter POTS/ZC1/16KHz/ST
	SAI001 ST	ADSL Splitter RDSI/2B1Q-135/ST
	SAI002 ST	ADSL Splitter RDSI/4B3T-150/ST
	SAC001 ST	ADSL Splitter Combi/ZC1+2B1Q-135/ST
	SAC002 ST	ADSL Splitter Combi/ZC3+4B3T-150/ST
	SAC003 ST	ADSL Splitter Combi/600+2B1Q-135/ST

Simple ADSL Microfilter	Ref.	Description
	MFAS001	Simple ADSL Microfilter-POTS/600
	MFAS101	Simple ADSL Microfilter-POTS/ZC1
Dual ADSL Microfilter	Ref.	Description
	MFAD001	Dual ADSL Microfilter-POTS/600
	MFAD101	Dual ADSL Microfilter-POTS/ZC1
T ADSL Microfilter	Ref.	Description
	MFAT001	T ADSL Microfilter-POTS / 600
	MFAT101	T ADSL Microfilter-POTS/ZC1
Alarm ADSL Microfilter	Ref.	Description
	MFAA001	Alarm ADSL Microfilter-POTS/600
	MFAA101	Alarm ADSL Microfilter-POTS/ZC1

AM Filter	Ref.	Description
	FAM001	AM Filter-POTS/600

The ADSL Splitter separates the signal POTS (Plain Old Telephone Service) (voice) from the ADSL signal (data) allowing the simultaneous transmission of both services using the same cable (phone cable).

It allows to have in the subscriber's house two independent lines, voice and data, therefore all the analogical equipment can be used at the same time (telephones, fax, alarms, etc.), without the need of a microfilter for every equipment and without affecting the actual installation.

SAP001- To be used in conventional lines (POTS) and without billing tone.

Countries: Spain, Brazil, Chile, Japan, Argentina, Turkey, Uruguay, Colombia, Venezuela, Peru, Costa Rica, Italy, Portugal, South Africa, United Kingdom



- Ready for new ADSL 2 + technology
- Plastic material V.O. (Fireproof)
- RJ11 connector with gold covering (50µm)
- Exclusive design with safe cables fixing
- Designed according environment regulation ETS300019 part.1-1, class1.2; part1-2, class2.3; part.1-3, class3.2

Technical requirements

Voice specifications		General specifications	
Pass band (P.b.)	0-4 KHz	Resistance in loop	< 50 Ω
Line impedance	600 Ω	Line/ground isolation resistance	> 100 MΩ
Insertion losses in (B.p.)	< 1dB	Isolation resistance line	> 10 MΩ
Distortion of insert losses in (B.p.)	< 0,5 dB	Line connectors	1 RJ11 / 1 clamp IDC
Return losses in (B.p.)	> 20 dB	Phone connectors	1 RJ11 / 1 clamp IDC
ADSL band attenuation (32 KHz – 2,2 MHz)	> 55 dB	ADSL data connectors	1 RJ11
Maximum current (Imax) d.c.	100 mA	Wall mounting	2 screws/2 plastic plugs.
ADSL Specifications		Surface mounting	Adhesive tape
Impedance	100 Ω	Dimensions	(87x51x25) mm
Return losses (30 to 1,1Khz)	10 dB	Weight	85 gr

Installation and connections

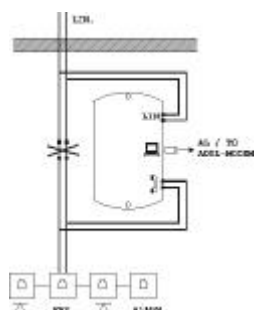

Installation diagram

The ADSL splitter must be placed in the entrance line point before any other equipment from the internal network.
Two fixing options: it can be fixed to a plain surface using adhesive tape or to a wall using 2 screws.

Two connection options

The connection can be done with IDC clamps (Insulation Displacement Connection) avoiding the stripping of phone cables, or for connector RJ11.

It contains

- Splitter ADSL HR-SAP001
- 2 screws and 2 plastic plugs.
- Adhesive tape.
- Installation instructions.

The ADSL Splitter separates the signal POTS (Plain Old Telephone Service) (voice) from the ADSL signal (data) allowing the simultaneous transmission of both services using the same cable (phone cable).

It allows to have in the subscriber's house two independent lines, voice and data, therefore all the analogical equipment can be used at the same time (telephones, fax, alarms, etc.), without the need of a microfilter for every equipment and without affecting the actual installation.

SAP020- To be used in conventional lines (POTS) and with billing tone.

Countries: U.S.A., Brazil, India, Russia, Greece, Turkey, Poland, Slovak, Austria, Island, Norway, Luxemburg, Byelorussia, Colombia, Chile, Egypt, Estonia, Lithuania, Rumania, Ukraine, Uruguay, Venezuela.



- Ready for new ADSL 2 + technology
- Plastic material V.O. (Fireproof)
- RJ11 connector with gold covering (50µm)
- Exclusive design with safe cables fixing
- Designed according environment regulation ETS300019 part.1-1, class1.2; part.1-2, class2.3; part.1-3, class3.2

Technical requirements

Voice specifications		General specifications	
Pass band (P.b.)	0-16 KHz	Resistance in loop	< 50 Ω
Line impedance	600 Ω	Line/ground isolation resistance	> 100 M Ω
Insertion losses in (B.p.)	< 1dB	Isolation resistance line	> 10 M Ω
Distortion of insert losses in (B.p.)	< 0,5 dB	Line connectors	1 RJ11 / 1 clamp IDC
Return losses in (B.p.)	> 20 dB	Phone connectors	1 RJ11 / 1 clamp IDC
ADSL band attenuation (32 KHz – 2,2 MHz)	> 55 dB	ADSL data connectors	1 RJ11
Maximum current (Imax) d.c.	100 mA	Wall mounting	2 screws/2 plastic plugs.
ADSL Specifications		Surface mounting	Adhesive tape
Impedance	100 Ω	Dimensions	(87x51x25) mm
Return losses (30 to 1,1Khz)	10 dB	Weight	85 gr

Installation and connections

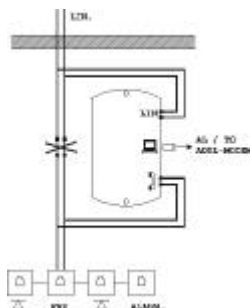

Installation diagram

The ADSL splitter must be placed in the entrance line point before any other equipment from the internal network.
Two fixing options: it can be fixed to a plain surface using adhesive tape or to a wall using 2 screws.

Two connection options

The connection can be done with IDC clamps (Insulation Displacement Connection) avoiding the stripping of phone cables, or for connector RJ11.

It contains

- Splitter ADSL HR-SAP020
- 2 screws and 2 plastic plugs.
- Adhesive tape.
- Installation instructions.

The ADSL Splitter separates the signal POTS (Plain Old Telephone Service) (voice) from the ADSL signal (data) allowing the simultaneous transmission of both services using the same cable (phone cable).

It allows to have in the subscriber's house two independent lines, voice and data, therefore all the analogical equipment can be used at the same time (telephones, fax, alarms, etc.), without the need of a microfilter for every equipment and without affecting the actual installation.

SAP100- To be used in conventional lines (POTS) and without billing tone.

Countries: Sweden, Switzerland, Australia.



- Ready for new ADSL 2 + technology
- Plastic material V.O. (Fireproof)
- RJ11 connector with gold covering (50µ")
- Exclusive design with safe cables fixing
- Designed according environment regulation ETS300019 part.1-1, class1.2; part1-2, class2.3; part.1-3, class3.2

Technical requirements

Voice specifications		General specifications	
Pass band (P.b.)	0-4 KHz	Resistance in loop	< 50 Ω
Line impedance	150nf // 750Ω±270Ω	Line/ground isolation resistance	> 100 M.Ω
Insertion losses in (B.p.)	< 1dB	Isolation resistance line	> 10 M.Ω
Distortion of insert losses in (B.p.)	< 0,5 dB	Line connectors	1 RJ11 / 1 clema IDC
Return losses in (B.p.)	> 20 dB	Phone connectors	1 RJ11 / 1 clema IDC
ADSL band attenuation (32 KHz – 2,2 MHz)	> 55 dB	ADSL data connectors	1 RJ11
Maximum current (Imax) d.c.	100 mA	Wall mounting	2 screws/2 plastic plugs.
ADSL Specificat ions		Surface mounting	Adhesive tape
Impedance	100 Ω	Dimensions	(87x51x25) mm
Return losses (30 to 1,1Khz)	10 dB	Weight	85 gr

Installation and connections

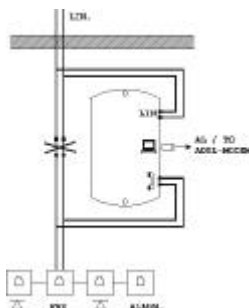

Installation diagram

The ADSL splitter must be placed in the entrance line point before any other equipment from the internal network.
Two fixing options: it can be fixed to a plain surface using adhesive tape or to a wall using 2 screws.

Two connection options

The connection can be done with IDC clamps (Insulation Displacement Connection) avoiding the stripping of phone cables, or for connector RJ11.

It contains

- Splitter ADSL HR-SAP100
- 2 screws and 2 plastic plugs.
- Adhesive tape.
- Installation instructions.

The ADSL Splitter separates the signal POTS (Plain Old Telephone Service) (voice) from the ADSL signal (data) allowing the simultaneous transmission of both services using the same cable (phone cable).

It allows to have in the subscriber's house two independent lines, voice and data, therefore all the analogical equipment can be used at the same time (telephones, fax, alarms, etc.), without the need of a microfilter for every equipment and without affecting the actual installation.

SAP120- To be used in conventional lines (POTS) and with billing tone.

Countries: Portugal, France, Italy, Sweden, Switzerland, Norway, Finland, Holland, Belgium, Australia, Bulgaria, Latvia, Check Republic, Ireland, Island, Denmark, Algeria, Morocco, United Kingdom, South Africa, Tunes.



- Ready for new ADSL 2 + technology
- Plastic material V.O. (Fireproof)
- RJ11 connector with gold covering (50µm)
- Exclusive design with safe cables fixing
- Designed according environment regulation ETS300019 part.1-1, class1.2; part1-2, class2.3; part.1-3, class3.2

Technical requirements

Voice specifications		General specifications	
Pass band (P.b.)	0-16 KHz	Resistance in loop	< 50 Ω
Line impedance	150nf // 750Ω±270Ω	Line/ground isolation resistance	> 100 MΩ
Insertion losses in (B.p.)	< 1dB	Isolation resistance line	> 10 MΩ
Distortion of insert losses in (B.p.)	< 0,5 dB	Line connectors	1 RJ11 / 1 clema IDC
Return losses in (B.p.)	> 20 dB	Phone connectors	1 RJ11 / 1 clema IDC
ADSL band attenuation (32 KHz – 2,2 MHz)	> 55 dB	ADSL data connectors	1 RJ11
Maximum current (Imax) d.c.	100 mA	Wall mounting	2 screws/2 plastic plugs.
ADSL Specifications		Surface mounting	Adhesive tape
Impedance	100 Ω	Dimensions	(87x51x25) mm
Return losses (30 to 1,1Khz)	10 dB	Weight	85 gr

Installation and connections

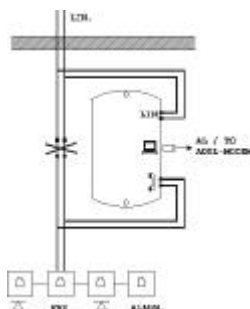

Installation diagram

The ADSL splitter must be placed in the entrance line point before any other equipment from the internal network.
Two fixing options: it can be fixed to a plain surface using adhesive tape or to a wall using 2 screws.

Two connection options

The connection can be done with IDC clamps (Insulation Displacement Connection) avoiding the stripping of phone cables, or for connector RJ11.

It contains

- Splitter ADSL HR-SAP120
- 2 screws and 2 plastic plugs.
- Adhesive tape.
- Installation instructions.

The ADSL Splitter separates the signal ISDN (voice) from the ADSL signal (data) allowing the simultaneous transmission of both services using the same cable (phone cable).

It allows to have in the subscriber's house two independent lines, voice and data, therefore all the analogical equipment can be used at the same time (telephones, fax, alarms, etc.), without the need of a microfilter for every equipment and without affecting the actual installation.

SAI001- To be used in ISDN lines (2B1Q-135Ω)

Countries: Belgium, Canada, Cyprus, Holland, Hungary.



- Ready for new ADSL 2+ technology
- Plastic material V.O. (Fireproof)
- RJ11 connector with gold covering (50μm)
- Exclusive design with safe cables fixing
- Designed according environment regulation ETS300019 part.1-1, class1.2; part1-2, class2.3; part.1-3, class3.2

Technical requirements

Voice specifications		General specifications	
Pass band (P.b.)	0 - 96 KHz	Resistance in loop	< 50 Ω
Line impedance	135 Ω	Line/ground isolation resistance	> 100 M Ω
Insertion losses in (1KHz - 40KHz) / (40KHz - 80KHz)	< 0,8dB / < 2dB	Isolation resistance line	> 10 M Ω
Distortion of insert losses in (B.p.)	< 0,5 dB	Line connectors	1 RJ11 / 1 clema IDC
Return losses in (1KHz - 40KHz) / (40KHz - 80KHz)	> 18 Db / > 14dB	Phone connectors	1 RJ11 / 1 clema IDC
ADSL band attenuation (32 KHz - 2,2 MHz)	> 55 dB	ADSL data connectors	1 RJ11
Maximum current (Imax) d.c.	100 mA	Wall mounting	2 screws/2 plastic plugs.
ADSL Specifications		Surface mounting	Adhesive tape
Impedance	100 Ω	Dimensions	(87x51x25) mm
Return losses (30 to 1,1Khz)	10 dB	Weight	85 gr

Installation and connections

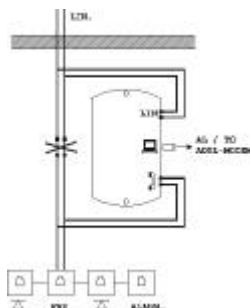

Installation diagram

The ADSL splitter must be placed in the entrance line point before any other equipment from the internal network.
Two fixing options: it can be fixed to a plain surface using adhesive tape or to a wall using 2 screws.

Two connection options

The connection can be done with IDC clamps (Insulation Displacement Connection) avoiding the stripping of phone cables, or for connector RJ11.

It contains

- Splitter ADSL HR-SAI001
- 2 screws and 2 plastic plugs.
- Adhesive tape.
- Installation instructions.

The ADSL Splitter separates the signal ISDN (voice) from the ADSL signal (data) allowing the simultaneous transmission of both services using the same cable (phone cable).

It allows to have in the subscriber's house two independent lines, voice and data, therefore all the analogical equipment can be used at the same time (telephones, fax, alarms, etc.), without the need of a microfilter for every equipment and without affecting the actual installation.

SAI002 - To be used in conventional lines ISDN (4B3T-150 Ω)

Countries: Russia.



- Ready for new ADSL 2 + technology
- Plastic material V.O. (Fireproof)
- RJ11 connector with gold covering (50 μ m)
- Exclusive design with safe cables fixing
- Designed according environment regulation ETS300019 part.1-1, class1.2; part.1-2, class2.3; part.1-3, class3.2

Technical requirements

Voice specifications		General specifications	
Pass band (P.b.)	0 - 96 KHz	Resistance in loop	< 50 Ω
Line impedance	150 Ω	Line/ground isolation resistance	> 100 M Ω
Insertion losses in (1KHz - 40KHz) / (40KHz - 80KHz)	< 1,2dB / < 2dB	Isolation resistance line	> 10 M Ω
Distortion of insert losses in (B.p.)	< 0,5 dB	Line connectors	1 RJ11 / 1 clema IDC
Return losses in (1KHz - 40KHz) / (40KHz - 80KHz)	> 18 Db / > 14dB	Phone connectors	1 RJ11 / 1 clema IDC
ADSL band attenuation (32 KHz - 2,2 MHz)	> 55 dB	ADSL data connectors	1 RJ11
Maximum current (Imax) d.c.	100 mA	Wall mounting	2 screws/2 plastic plugs.
ADSL Specifications		Surface mounting	Adhesive tape
Impedance	100 Ω	Dimensions	(87x51x25) mm
Return losses (30 to 1,1KHz)	10 dB	Weight	85 gr

Installation and connections

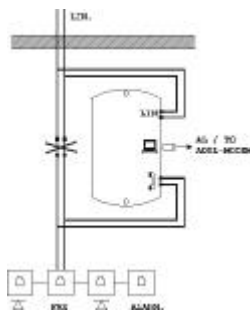

Installation diagram

The ADSL splitter must be placed in the entrance line point before any other equipment from the internal network.
Two fixing options: it can be fixed to a plain surface using adhesive tape or to a wall using 2 screws.

Two connection options

The connection can be done with IDC clamps (Insulation Displacement Connection) avoiding the stripping of phone cables, or for connector RJ11.

It contains

- Splitter ADSL HR-SAI002
- 2 screws and 2 plastic plugs.
- Adhesive tape.
- Installation instructions.

The ADSL Splitter separates the signal POTS (Plain Old Telephone Service) (voice) from the ADSL signal (data) allowing the simultaneous transmission of both services using the same cable (phone cable).

It allows to have in the subscriber's house two independent lines, voice and data, therefore all the analogical equipment can be used at the same time (telephones, fax, alarms, etc.), without the need of a microfilter for every equipment and without affecting the actual installation.

SAC001- To be used in conventional mix lines (POTS) and ISDN.

Countries: Norway.



- Ready for new ADSL 2 + technology
- Plastic material V.O. (Fireproof)
- RJ11 connector with gold covering (50µm)
- Exclusive design with safe cables fixing
- Designed according environment regulation ETS300019 part.1-1, class1.2; part1-2, class2.3; part.1-3, class3.2

Technical requirements

Voice specifications		General specifications	
Pass band (P.b.)	0-96 KHz	Resistance in loop	< 50 Ω
Line impedance	115nf // 820Ω±220Ω	Line/ground isolation resistance	> 100 MΩ
Insertion losses in (B.p.)	< 1dB	Isolation resistance line	> 10 MΩ
Distortion of insert losses in (B.p.)	< 0,5 dB	Line connectors	1 RJ11 / 1 clamp IDC
Return losses in (B.p.)	> 20 dB	Phone connectors	1 RJ11 / 1 clamp IDC
ADSL band attenuation (32 KHz – 2,2 MHz)	> 55 dB	ADSL data connectors	1 RJ11
Maximum current (Imax) d.c.	100 mA	Wall mounting	2 screws/2 plastic plugs.
ADSL Specifications		Surface mounting	Adhesive tape
Impedance	100 Ω	Dimensions	(87x51x25) mm
Return losses (30 to 1,1Khz)	10 dB	Weight	85 gr

Installation and connections

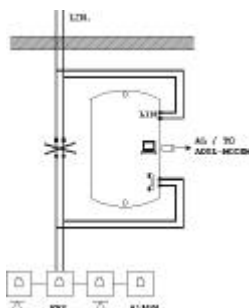

Installation diagram

The ADSL splitter must be placed in the entrance line point before any other equipment from the internal network.
Two fixing options: it can be fixed to a plain surface using adhesive tape or to a wall using 2 screws.

Two connection options

The connection can be done with IDC clamps (Insulation Displacement Connection) avoiding the stripping of phone cables, or for connector RJ11.

It contains

- Splitter ADSL HR-SAC001
- 2 screws and 2 plastic plugs.
- Adhesive tape.
- Installation instructions.



The ADSL Splitter separates the signal POTS (Plain Old Telephone Service) (voice) from the ADSL signal (data) allowing the simultaneous transmission of both services using the same cable (phone cable).

It allows to have in the subscriber's house two independent lines, voice and data, therefore all the analogical equipment can be used at the same time (telephones, fax, alarms, etc.), without the need of a microfilter for every equipment and without affecting the actual installation.

SAC002- To be used in conventional mix lines (POTS) and ISDN.

Countries: Germany.

- Ready for new ADSL 2 + technology
- Plastic material V.O. (Fireproof)
- RJ11 connector with gold covering (50µm)
- Exclusive design with safe cables fixing
- Designed according environment regulation ETS300019 part.1-1, class1.2; part1-2, class2.3; part.1-3, class3.2

Technical requirements

Voice specifications		General specifications	
Pass band (P.b.)	0-96 KHz	Resistance in loop	< 50 Ω
Line impedance	115nf // 820Ω±220Ω	Line/ground isolation resistance	> 100 M Ω
Insertion losses in (B.p.)	< 1dB	Isolation resistance line	> 10 M Ω
Distortion of insert losses in (B.p.)	< 0,5 dB	Line connectors	1 RJ11 / 1 clema IDC
Return losses in (B.p.)	> 20 dB	Phone connectors	1 RJ11 / 1 clema IDC
ADSL band attenuation (32 KHz – 2,2 MHz)	> 55 dB	ADSL data connectors	1 RJ11
Maximum current (Imax) d.c.	100 mA	Wall mounting	2 screws/2 plastic plugs.
ADSL Specifications		Surface mounting	Adhesive tape
Impedance	Dimensions	Dimensions	(87x51x25) mm
Return losses (30 to 1,1Khz)	Weight	Weight	85 gr

Installation and connections

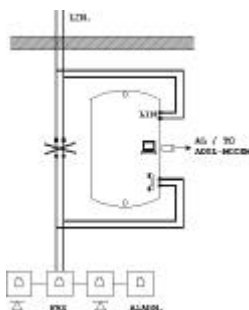

Installation diagram

The ADSL splitter must be placed in the entrance line point before any other equipment from the internal network. Two fixing options: it can be fixed to a plain surface using adhesive tape or to a wall using 2 screws.



Two connection options

The connection can be done with IDC clamps (Insulation Displacement Connection) avoiding the stripping of phone cables, or for connector RJ11.



It contains

- Splitter ADSL HR-SAC002
- 2 screws and 2 plastic plugs.
- Adhesive tape.
- Installation instructions.

The ADSL Splitter separates the signal POTS (Plain Old Telephone Service) (voice) from the ADSL signal (data) allowing the simultaneous transmission of both services using the same cable (phone cable).

It allows to have in the subscriber's house two independent lines, voice and data, therefore all the analogical equipment can be used at the same time (telephones, fax, alarms, etc.), without the need of a microfilter for every equipment and without affecting the actual installation.

SAC003- To be used in conventional mix lines (POTS) and ISDN.

Countries: Hungary.



- Ready for new ADSL 2 + technology
- Plastic material V.O. (Fireproof)
- RJ11 connector with gold covering (50µm)
- Exclusive design with safe cables fixing
- Designed according environment regulation ETS300019 part.1-1, class1.2; part1-2, class2.3; part.1-3, class3.2

Technical requirements

Voice specifications		General specifications	
Pass band (P.b.)	0-96 KHz	Resistance in loop	< 50 Ω
Line impedance	600Ω±150Ω	Line/ground isolation resistance	> 100 M Ω
Insertion losses in (B.p.)	< 1dB	Isolation resistance line	> 10 M Ω
Distortion of insert losses in (B.p.)	< 0,5 dB	Line connectors	1 RJ11 / 1 clema IDC
Return losses in (B.p.)	> 20 dB	Phone connectors	1 RJ11 / 1 clema IDC
ADSL band attenuation (32 KHz – 2,2 MHz)	> 55 dB	ADSL data connectors	1 RJ11
Maximum current (Imax) d.c.	100 mA	Wall mounting	2 screws/2 plastic plugs.
ADSL Specifications		Surface mounting	Adhesive tape
Impedance	Dimensions	Dimensions	(87x51x25) mm
Return losses (30 to 1,1Khz)	Weight	Weight	85 gr

Installation and connections

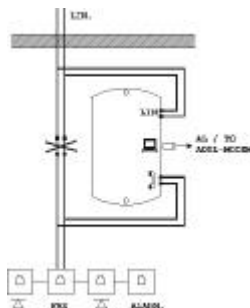

Installation diagram

The ADSL splitter must be placed in the entrance line point before any other equipment from the internal network.
Two fixing options: it can be fixed to a plain surface using adhesive tape or to a wall using 2 screws.

Two connection options

The connection can be done with IDC clamps (Insulation Displacement Connection) avoiding the stripping of phone cables, or for connector RJ11.

It contains

- Splitter ADSL HR-SAC003
- 2 screws and 2 plastic plugs.
- Adhesive tape.
- Installation instructions.

The ADSL Splitter separates the signal POTS (Plain Old Telephone Service) (voice) from the ADSL signal (data) allowing the simultaneous transmission of both services using the same cable (phone cable).

It include a switch and test system for easy voice and data maintenance from the same splitter.

It allows to have in the subscriber's house two independent lines, voice and data, therefore all the analogical equipment can be used at the same time (telephones, fax, alarms, etc.), without the need of a microfilter for every equipment and without affecting the actual installation.

SAP001ST- To be used in conventional lines (POTS) and without billing tone.

Countries: Spain, Brazil, Chile, Japan, Argentina, Turkey, Uruguay, Colombia, Venezuela, Peru, Costa Rica, Italy, Portugal, South Africa, United Kingdom



- Ready for new ADSL 2 + technology
- Plastic material V.O. (Fireproof)
- RJ11 connector with gold covering (50µ")
- Exclusive design.
- Overvoltage protection with gas discharger.
- Designed according environment regulation ETS300019 part.1-1, class1.2; part1-2, class2.3; part.1-3, class3.2

Technical requirements

Voice specifications		General specifications	
Pass band (P.b.)	0-4 KHz	Resistance in loop	< 50 Ω
Line impedance	600 Ω	Line/ground isolation resistance	> 100 M Ω
Insertion losses in (B.p.)	< 1dB	Isolation resistance line	> 10 M Ω
Distortion of insert losses in (B.p.)	< 0,5 dB	Line connectors	1 clamp connector
Return losses in (B.p.)	> 20 dB	Phone connectors	1 RJ11 / 1 clamp connector
ADSL band attenuation (32 KHz – 2,2 MHz)	> 55 dB	ADSL data connectors	1 RJ45 / 1 clamp connector
Maximum current (Imax) d.c.	100 mA	Wall mounting	2 screws /2plastic screws / plastic holder
ADSL Specifications		Surface mounting	Plastic holder
Impedance	100 Ω	Dimensions	(108x69x29) mm
Return losses (30 to 1,1Khz)	10 dB	Weight	150 gr

Installation and connections

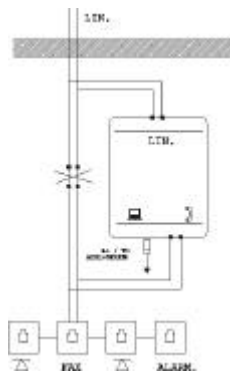

Installation diagram

The ADSL splitter must be placed in the entrance line point before any other equipment from the internal network.
Fixing: With a plastic holder and 2 screws.



Two connection options

The connection can be done with clamp connectors (previously stripped at 7 mm) of phone cables, or with RJ11 connector .



It contains

- Splitter ADSL HR-SAP001ST
- 2 screws and 2 plastic plugs.
- Wall plastic holder.
- Installation instructions.

The ADSL Splitter separates the signal POTS (Plain Old Telephone Service) (voice) from the ADSL signal (data) allowing the simultaneous transmission of both services using the same cable (phone cable).

It include a switch and test system for easy voice and data maintenance from the same splitter.

It allows to have in the subscriber's house two independent lines, voice and data, therefore all the analogical equipment can be used at the same time (telephones, fax, alarms, etc.), without the need of a microfilter for every equipment and without affecting the actual installation.

SAP020ST - To be used in conventional lines (POTS) and with billing tone.

Countries: U.S.A., Brazil, India, Russia, Greece, Turkey, Poland, Slovak, Austria, Island, Norway, Luxemburg, Byelorussia, Colombia, Chile, Egypt, Estonia, Lithuania, Rumania, Ukraine, Uruguay, Venezuela.



- Ready for new ADSL 2 + technology
- Plastic material V.O. (Fireproof)
- RJ11 connector with gold covering (50µ")
- Exclusive design.
- Overvoltage protection with gas discharger.
- Designed according environment regulation ETS300019 part.1-1, class1.2; part1-2, class2.3; part.1-3, class3.2

Technical requirements

Voice specifications		General specifications	
Pass band (P.b.)	0-16 KHz	Resistance in loop	< 50 Ω
Line impedance	600 Ω	Line/ground isolation resistance	> 100 M Ω
Insertion losses in (B.p.)	< 1dB	Isolation resistance line	> 10 M Ω
Distortion of insert losses in (B.p.)	< 0,5 dB	Line connectors	1 clamp connector
Return losses in (B.p.)	> 20 dB	Phone connectors	1 RJ11 / 1 clamp connector
ADSL band attenuation (32 KHz – 2,2 MHz)	> 55 dB	ADSL data connectors	1 RJ45 / 1 clamp connector
Maximum current (Imax) d.c.	100 mA	Wall mounting	2 screws /2plastic screws / plastic holder
ADSL Specifications		Surface mounting	Plastic holder
Impedance	Dimensions	Dimensiones	(108x69x29) mm
Return losses (30 to 1,1Khz)	Weight	Peso	150 gr

Installation and connections

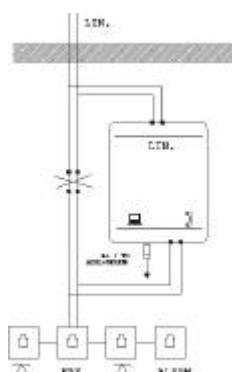

Installation diagram

The ADSL splitter must be placed in the entrance line point before any other equipment from the internal network.
Fixing: With a plastic holder and 2 screws.

Two connection options

The connection can be done with clamp connectors (previously stripped at 7 mm) of phone cables, or with RJ11 connector .

It contains

- Splitter ADSL HR-SAP020ST
- 2 screws and 2 plastic plugs.
- Wall plastic holder.
- Installation instructions.



HR-SAP100ST

Splitter ADSL POTS/ZC1/4KHz/ST

The ADSL Splitter separates the signal POTS (Plain Old Telephone Service) (voice) from the ADSL signal (data) allowing the simultaneous transmission of both services using the same cable (phone cable).

It include a switch and test system for easy voice and data maintenance from the same splitter.

It allows to have in the subscriber's house two independent lines, voice and data, therefore all the analogical equipment can be used at the same time (telephones, fax, alarms, etc.), without the need of a microfilter for every equipment and without affecting the actual installation.

SAP100ST - To be used in conventional lines (POTS) and without billing tone.

Countries: Sweden, Switzerland, Australia.



- Ready for new ADSL 2 + technology
- Plastic material V.O. (Fireproof)
- RJ11 connector with gold covering (50µ"")
- Exclusive design.
- Overvoltage protection with gas discharger.
- Designed according environment regulation ETS300019 part.1-1, class1.2; part1-2, class2.3; part.1-3, class3.2

Technical requirements

Voice specifications		General specifications	
Pass band (P.b.)	0-4 KHz	Resistance in loop	< 50 Ω
Line impedance	150nf // 750Ω±270Ω	Line/ground isolation resistance	> 100 M Ω
Insertion losses in (B.p.)	< 1dB	Isolation resistance line	> 10 M Ω
Distortion of insert losses in (B.p.)	< 0,5 dB	Line connectors	1 clamp connector
Return losses in (B.p.)	> 20 dB	Phone connectors	1 RJ11 / 1 clamp connector
ADSL band attenuation (32 KHz – 2,2 MHz)	> 55 dB	ADSL data connectors	1 RJ45 / 1 clamp connector
Maximum current (Imax) d.c.	100 mA	Wall mounting	2 screws /2plastic screws / plastic holder
ADSL Specifications		Surface mounting	Plastic holder
Impedance	100 Ω	Dimensions	(108x69x29) mm
Return losses (30 to 1,1Khz)	10 dB	Weight	150gr

Installation and connections

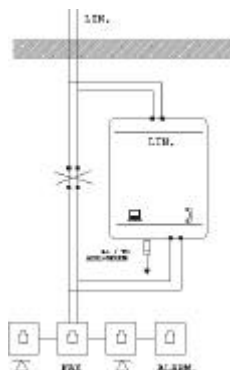

Installation diagram

The ADSL splitter must be placed in the entrance line point before any other equipment from the internal network.
Fixing: With a plastic holder and 2 screws.



Two connection options

The connection can be done with clamp connectors (previously stripped at 7 mm) of phone cables, or with RJ11 connector .



It contains

- Splitter ADSL HR-SAP100ST
- 2 screws and 2 plastic plugs.
- Wall plastic holder.
- Installation instructions.



HR-SAP120ST

Splitter ADSL POTS/ZC1/16KHz/ST

The ADSL Splitter separates the signal POTS (Plain Old Telephone Service) (voice) from the ADSL signal (data) allowing the simultaneous transmission of both services using the same cable (phone cable).

It include a switch and test system for easy voice and data maintenance from the same splitter.

It allows to have in the subscriber's house two independent lines, voice and data, therefore all the analogical equipment can be used at the same time (telephones, fax, alarms, etc.), without the need of a microfilter for every equipment and without affecting the actual installation.

SAP120ST - To be used in conventional lines (POTS) and with billing tone.

Countries: Portugal, France, Italy, Sweden, Switzerland, Norway, Finland, Holland, Belgium, Australia, Bulgaria, Latvia, Check Republic, Ireland, Island, Denmark, Algeria, Morocco, United Kingdom, South Africa, Tunes.



- Ready for new ADSL 2 + technology
- Plastic material V.O. (Fireproof)
- RJ11 connector with gold covering (50µ")
- Exclusive design.
- Overvoltage protection with gas discharger.
- Designed according environment regulation ETS300019 part.1-1, class1.2; part1-2, class2.3; part.1-3, class3.2

Technical requirements

Voice specifications		General specifications	
Banda de paso (B.p.)	0-16 KHz	Resistance in loop	< 50 Ω
Impedancia de referencia	150nf // 750Ω±270Ω	Line/ground isolation resistance	> 100 MΩ
Perdidas de inserción en (B.p.)	< 1dB	Isolation resistance line	> 10 MΩ
Distorsión pérdidas de inserción en (B.p.)	< 0,5 dB	Line connectors	1 clamp connector
Pérdidas de retorno en (B.p.)	> 20 dB	Phone connectors	1 RJ11 / 1 clamp connector
Atenuación banda ADSL (32 KHz – 2,2 MHz)	> 55 dB	ADSL data connectors	1 RJ45 / 1 clamp connector
Corriente máx. (Imax) c.c.	100 mA	Wall mounting	2 screws /2plastic screws / plastic holder
ADSL Specifications		Surface mounting	Plastic holder
Impedance	100 Ω	Dimensions	(108x69x29) mm
Return losses (30 to 1,1KHz)	10 dB	Weight	150 gr

Installation and connections

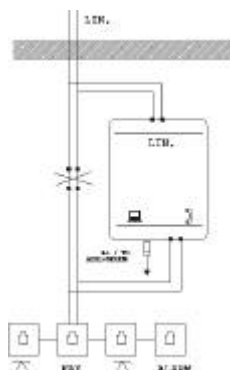

Installation diagram

The ADSL splitter must be placed in the entrance line point before any other equipment from the internal network.
Two fixing options: it can be fixed to a plain surface using adhesive tape or to a wall using 2 screws.

Two connection options

The connection can be done with clamp connectors (previously stripped at 7 mm) of phone cables, or with RJ11 connector .

It contains

- Splitter ADSL HR-SAP120ST
- 2 screws and 2 plastic plugs.
- Wall plastic holder.
- Installation instructions.



HR-SAI001ST

Splitter ADSL RDSI/2B1Q-135/ST

The ADSL Splitter separates the signal POTS (Plain Old Telephone Service) (voice) from the ADSL signal (data) allowing the simultaneous transmission of both services using the same cable (phone cable).
It include a switch and test system for easy voice and data maintenance from the same splitter.



It allows to have in the subscriber's house two independent lines, voice and data, therefore all the analogical equipment can be used at the same time (telephones, fax, alarms, etc.), without the need of a microfilter for every equipment and without affecting the actual installation.

- Ready for new ADSL 2 + technology
- Plastic material V.O. (Fireproof)
- RJ11 connector with gold covering (50µ")
- Exclusive design.
- Overvoltage protection with gas discharger.
- Designed according environment regulation ETS300019 part.1-1, class1.2; part1-2, class2.3; part.1-3, class3.2

SAI001ST- To be used in ISDN lines (2B1Q-135Ω)

Countries: Belgium, Canada, Cyprus, Holland, Hungary.

Technical requirements

Voice specifications		General specifications	
Pass band (P.b.)	0 - 96 KHz	Resistance in loop	< 50 Ω
Line impedance	135 Ω	Line/ground isolation resistance	> 100 M.Ω
Insertion losses in (B.p.)	< 0,8dB / <2dB	Isolation resistance line	> 10 M.Ω
Distortion of insert losses in (B.p.)	< 0,5 dB	Line connectors	1 clamp connector
Return losses in (B.p.)	> 18 Db / >14dB	Phone connectors	1 RJ11 / 1 clamp connector
ADSL band attenuation (32 KHz – 2,2 MHz)	> 55 dB	ADSL data connectors	1 RJ45 / 1 clamp connector
Maximum current (Imax) d.c.	100 mA	Wall mounting	2 screws /2plastic screws / plastic holder
ADSL Specifications		Surface mounting	Plastic holder
Impedance	100 Ω	Dimensions	(108x69x29) mm
Return losses (30 to 1,1Khz)	10 dB	Weight	150 gr

Installation and connections

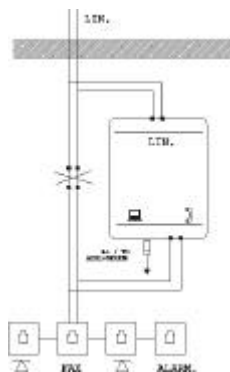

Installation diagram

The ADSL splitter must be placed in the entrance line point before any other equipment from the internal network.
 Fixing: With a plastic holder and 2 screws.



Two connection options

The connection can be done with clamp connectors (previously stripped at 7 mm) of phone cables, or with RJ11 connector .



It contains

- Splitter ADSL HR-SAI001ST
- 2 screws and 2 plastic plugs.
- Wall plastic holder.
- Installation instructions.

The ADSL Splitter separates the signal POTS (Plain Old Telephone Service) (voice) from the ADSL signal (data) allowing the simultaneous transmission of both services using the same cable (phone cable).
It include a switch and test system for easy voice and data maintenance from the same splitter.



Permite disponer en casa del abonado de dos líneas independientes, voz y datos, y así poder utilizar todos sus equipos analógicos actuales (teléfonos, fax, alarmas, etc.), sin necesidad de utilizar un microfiltro para cada equipo y sin afectar su instalación actual.

- Ready for new ADSL 2 + technology
- Plastic material V.O. (Fireproof)
- RJ11 connector with gold covering (50µ"")
- Exclusive design.
- Overvoltage protection with gas discharger.
- Designed according environment regulation ETS300019 part.1-1, class1.2; part1-2, class2.3; part.1-3, class3.2

SAI002ST - To be used in ISDN lines (4B3T-150Ω)

Countries: Russia.

Technical requirements

Voice specifications		General specifications	
Banda de paso (B.p.)	0 - 96 KHz	Resistencia bucle abonado	< 50 Ω
Impedancia de referencia	150 Ω	Resistencia de aislamiento línea / tierra	> 100 M.Ω
Pérdidas de inserción en (1KHz - 40KHz) / (40KHz - 80KHz)	< 1,2dB / <2dB	Resistencia de aislamiento entre línea	> 10 M.Ω
Distorsión pérdidas de inserción en (B.p.)	< 0,5 dB	Conectores línea	1 clamp connector
Pérdidas de retorno en (1KHz - 40KHz) / (40KHz - 80KHz)	> 18 Db / >14dB	Conectores teléfono	1 RJ11 / 1 clamp connector
Atenuación banda ADSL (32 KHz - 2,2 MHz)	> 55 dB	Conectores datos ADSL	1 RJ45 / 1 clamp connector
Corriente máx. (Imax) c.c.	100 mA	Montaje en pared	2 tornillos/2 tacos plástico/ soporte plástico
ADSL Specifications		Montaje en superficie	
Impedancia	100 Ω	Dimensiones	(108x69x29) mm
Pérdidas de retorno (30 a 1,1KHz)	10 dB	Peso	150 gr

Installation and connections

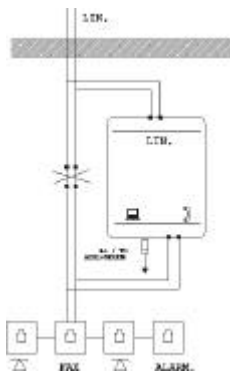

Installation diagram

El splitter ADSL debe colocarse en el punto de entrada de la línea antes de cualquier equipo de la red interna.
 Sistema de fijación: Mediante soporte de plástico y 2 tornillos.

Two connection options

The connection can be done with clamp connectors (previously stripped at 7 mm) of phone cables, or with RJ11 connector .

It contains

- Splitter ADSL HR-SAI002ST
- 2 Tornillos y 2 tacos.
- Soporte plástico pared.
- Instrucciones de instalación.

The ADSL Splitter separates the signal POTS (Plain Old Telephone Service) (voice) from the ADSL signal (data) allowing the simultaneous transmission of both services using the same cable (phone cable).

It include a switch and test system for easy voice and data maintenance from the same splitter.

It allows to have in the subscriber's house two independent lines, voice and data, therefore all the analogical equipment can be used at the same time (telephones, fax, alarms, etc.), without the need of a microfilter for every equipment and without affecting the actual installation.

SAC001ST- To be used in conventional (POTS) and ISDN lines.

Countries: Norway.



- Ready for new ADSL 2 + technology
- Plastic material V.O. (Fireproof)
- RJ11 connector with gold covering (50µm)
- Exclusive design.
- Overvoltage protection with gas discharger.
- Designed according environment regulation ETS300019 part.1-1, class1.2; part1-2, class2.3; part.1-3, class3.2

Technical requirements

Voice specifications		General specifications	
Pass band (P.b.)	0-96 KHz	Resistance in loop	< 50 Ω
Line impedance	115nf // 820Ω±220Ω	Line/ground isolation resistance	> 100 M Ω
Insertion losses in (B.p.)	< 1dB	Isolation resistance line	> 10 M Ω
Distortion of insert losses in (B.p.)	< 0,5 dB	Line connectors	1 clamp connector
Return losses in (B.p.)	> 20 dB	Phone connectors	1 RJ11 / 1 clamp connector
ADSL band attenuation (32 KHz – 2,2 MHz)	> 55 dB	ADSL data connectors	1 RJ45 / 1 clamp connector
Maximum current (Imax) d.c.	100 mA	Wall mounting	2 screws /2plastic screws / plastic holder
ADSL Specifications		Surface mounting	Plastic holder
Impedance	100Ω	Dimensions	(108x69x29) mm
Return losses (30 to 1,1Khz)	10 dB	Weight	150gr

Installation and connections

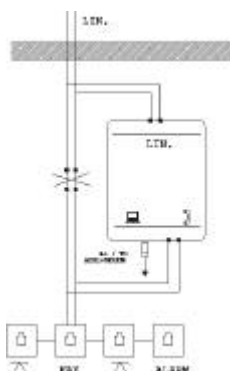

Installation diagram

The ADSL splitter must be placed in the entrance line point before any other equipment from the internal network.
Fixing: With a plastic holder and 2 screws.



Two connection options

The connection can be done with clamp connectors (previously stripped at 7 mm) of phone cables, or with RJ11 connector .



It contains

- Splitter ADSL HR-SAC001ST
- 2 screws and 2 plastic plugs.
- Wall plastic holder.
- Installation instructions.

The ADSL Splitter separates the signal POTS (Plain Old Telephone Service) (voice) from the ADSL signal (data) allowing the simultaneous transmission of both services using the same cable (phone cable).

It include a switch and test system for easy voice and data maintenance from the same splitter.

It allows to have in the subscriber's house two independent lines, voice and data, therefore all the analogical equipment can be used at the same time (telephones, fax, alarms, etc.), without the need of a microfilter for every equipment and without affecting the actual installation.

SAC002ST- To be used in conventional (POTS) and ISDN lines.

Countries: Germany.



- Ready for new ADSL 2 + technology
- Plastic material V.O. (Fireproof)
- RJ11 connector with gold covering (50µm)
- Exclusive design.
- Overvoltage protection with gas discharger.
- Designed according environment regulation ETS300019 part.1-1, class1.2; part1-2, class2.3; part.1-3, class3.2

Technical requirements

Voice specifications		General specifications	
Pass band (P.b.)	0-96 KHz	Resistance in loop	< 50 Ω
Line impedance	115nf // 820Ω±220Ω	Line/ground isolation resistance	> 100 M Ω
Insertion losses in (B.p.)	< 1dB	Isolation resistance line	> 10 M Ω
Distortion of insert losses in (B.p.)	< 0,5 dB	Line connectors	1 clamp connector
Return losses in (B.p.)	> 20 dB	Phone connectors	1 RJ11 / 1 clamp connector
ADSL band attenuation (32 KHz – 2,2 MHz)	> 55 dB	ADSL data connectors	1 RJ45 / 1 clamp connector
Maximum current (Imax) d.c.	100 mA	Wall mounting	2 screws /2plastic screws / plastic holder
ADSL Specifications		Surface mounting	Plastic holder
Impedance	100 Ω	Dimensions	(108x69x29) mm
Return losses (30 to 1,1Khz)	10 dB	Weight	150gr

Instalación y conexiones

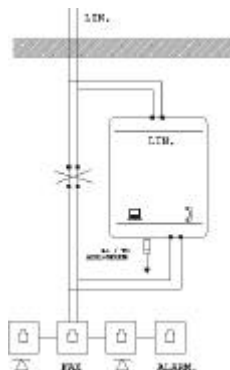

Installation diagram

The ADSL splitter must be placed in the entrance line point before any other equipment from the internal network.
Fixing: With a plastic holder and 2 screws.

Two connection options

The connection can be done with clamp connectors (previously stripped at 7 mm) of phone cables, or with RJ11 connector .

It contains

- Splitter ADSL HR-SAC002ST
- 2 screws and 2 plastic plugs.
- Wall plastic holder.
- Installation instructions.

The ADSL Splitter separates the signal POTS (Plain Old Telephone Service) (voice) from the ADSL signal (data) allowing the simultaneous transmission of both services using the same cable (phone cable).

It include a switch and test system for easy voice and data maintenance from the same splitter.

It allows to have in the subscriber's house two independent lines, voice and data, therefore all the analogical equipment can be used at the same time (telephones, fax, alarms, etc.), without the need of a microfilter for every equipment and without affecting the actual installation.

SAC003ST- To be used in conventional (POTS) and ISDN lines.

Countries: Hungary.



- Ready for new ADSL 2 + technology
- Plastic material V.O. (Fireproof)
- RJ11 connector with gold covering (50µm)
- Exclusive design.
- Overvoltage protection with gas discharger.
- Designed according environment regulation ETS300019 part.1-1, class1.2; part1-2, class2.3; part.1-3, class3.2

Technical requirements

Voice specifications		General specifications	
Pass band (P.b.)	0-96 KHz	Resistance in loop	< 50 Ω
Line impedance	600Ω±150Ω	Line/ground isolation resistance	> 100 M Ω
Insertion losses in (B.p.)	< 1 dB	Isolation resistance line	> 10 M Ω
Distortion of insert losses in (B.p.)	< 0,5 dB	Line connectors	1 clamp connector
Return losses in (B.p.)	> 20 dB	Phone connectors	1 RJ11 / 1 clamp connector
ADSL band attenuation (32 KHz – 2,2 MHz)	> 55 dB	ADSL data connectors	1 RJ45 / 1 clamp connector
Maximum current (Imax) d.c.	100 mA	Wall mounting	2 screws /2plastic screws / plastic holder
ADSL Specifications		Surface mounting	Plastic holder
Impedance	100 Ω	Dimensions	(108x69x29) mm
Return losses (30 to 1,1Khz)	10 dB	Weight	150gr

Installation and connections

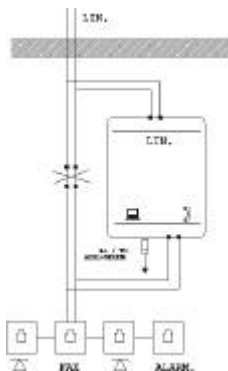

Installation diagram

The ADSL splitter must be placed in the entrance line point before any other equipment from the internal network.
Fixing: With a plastic holder and 2 screws.



Two connection options

The connection can be done with clamp connectors (previously stripped at 7 mm) of phone cables, or with RJ11 connector .



It contains

- Splitter ADSL HR-SAC003ST
- 2 screws and 2 plastic plugs.
- Wall plastic holder.
- Installation instructions.

The ADSL microfilter allows the transmission of the voice signal, (low pass band filter) and avoids the transmission of the ADSL signal to the phone or other equipment connected to the output. The voice signal keeps a high quality without distortions or noises.

The maximum number of microfilters that can be installed in the same line is 3, if higher an HR splitter must be used.

MFAS001- To be used in conventional lines (POTS) and without billing tone.

Countries: Argentina, Brazil, Colombia, Costa Rica, Chile, Egypt, Spain, Estonia, Greece, India, Island, Italy, Japan, Luxemburg, Peru, Poland, Portugal, Rumania, South Africa, Turkey, Uruguay, U.S.A., Venezuela

- Ready for new ADSL 2 + technology.
- Plastic material (Fireproof).
- RJ11 connector with gold covering (50µm)
- Exclusive design
- Designed according environment regulation ETS300019 part.1-1, class1.2; part1-2, class2.3; part.1-3, class3.2



Technical requirements

Voice specifications		General specifications	
Pass band (P.b.)	0-4 KHz	Resistance in loop	< 50 Ω
Line impedance	600 Ω	Line/ground isolation resistance	> 100 M Ω
Insertion losses in (B.p.)	< 0,32dB	Isolation resistance line	> 10 M Ω
Distortion of insert losses in (B.p.)	< 0,5 dB	Line connectors (length 15 cm)	Cable with RJ11
Return losses to 200Hz : 1MFA - (3MFA)	> 10,2 dB – (>10,2DdB)	Phone connectors	1 RJ11
Return losses to 3,5KHz : 1MFA - (3MFA)	> 12 dB – (>10,5 dB)	ADSL data connectors	NO
Return losses to 4,4KHz : 1MFA - (3MFA)	> 14 dB – (>12,5 dB)	Surface mounting	Adhesive tape
ADSL band attenuation (32 KHz – 2,2 MHz)	> 20 dB	Dimensions	(59x27x23) mm
Maximum current (Imax) d.c.	100 mA	Weight	35 gr

Installation and connections

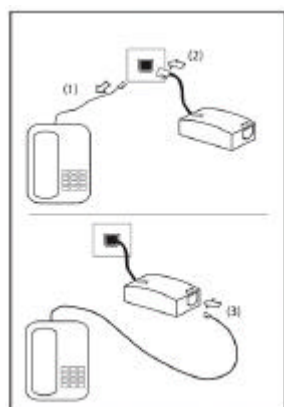
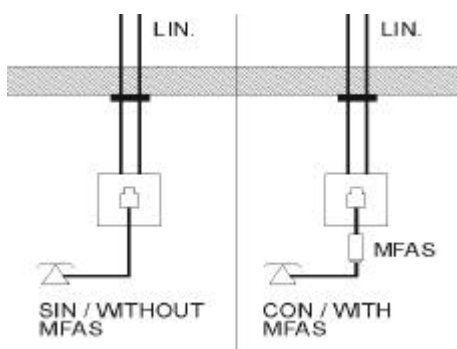

Installation diagram

The ADSL microfilter must be placed between the line entrance and the phone, fax or alarm. As shown in the diagram.

Installation process

- 1- Unplug the phone cable from the line output.
- 2- Connect the microfilter to the line output.
- 3- Connect the phone cable to the microfilter connector RJ11 (telephone).

It contains

- Microfilter MFAS001
- Adhesive tape
- Installation instructions.

The ADSL microfilter allows the transmission of the voice signal, (low pass band filter) and avoids the transmission of the ADSL signal to the phone or other equipment connected to the output. The voice signal keeps a high quality without distortions or noises.



The maximum number of microfilters that can be installed in the same line is 3, if higher an HR splitter must be used.

MFAS101- To be used in conventional lines (POTS) and without billing tone.

- Ready for new ADSL 2 + technology.
- Plastic material (Fireproof).
- RJ11 connector with gold covering (50µ"")
- Exclusive design
- Designed according environment regulation ETS300019 part.1-1, class1.2; part1-2, class2.3; part.1-3, class3.2

Countries: Australia, Belgium, Bulgaria, Canada, Cyprus, Holland, Ireland, Check Republic, Sweden, Tunes.

Technical requirements

Voice specifications		General specifications	
Pass band (P.b.)	0-4 KHz	Resistance in loop	< 50 Ω
Line impedance	150rfl // 750Ω + 270 Ω	Line/ground isolation resistance	> 100 MΩ
Insertion losses in (B.p.)	< 0,32dB	Isolation resistance line	> 10 MΩ
Distortion of insert losses in (B.p.)	< 0,5 dB	Line connectors (length 15 cm)	Cable with RJ11
Return losses to 200Hz : 1MFA - (3MFA)	> 10,2 dB – (>10,2DdB)	Phone connectors	1 RJ11
Return losses to 3,5KHz : 1MFA - (3MFA)	> 12 dB – (>10,5 dB)	ADSL data connectors	NO
Return losses to 4,4KHz : 1MFA - (3MFA)	> 14 dB – (>12,5 dB)	Surface mounting	Adhesive tape
ADSL band attenuation (32 KHz – 2,2 MHz)	> 20 dB	Dimensions	(59x27x23) mm
Maximum current (Imax) d.c.	100 mA	Weight	35 gr

Installation and connections

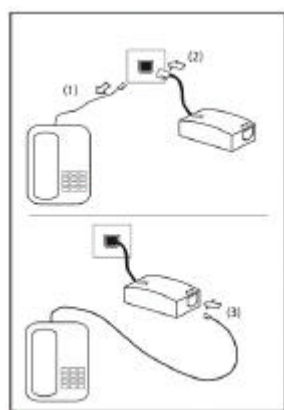
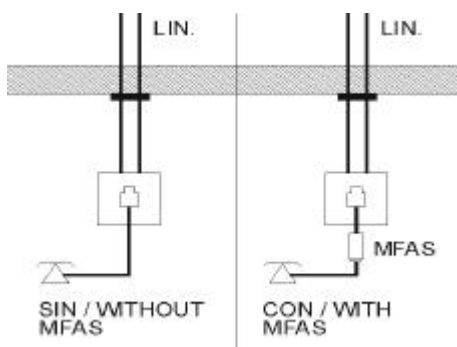

Installation diagram

The ADSL microfilter must be placed between the line entrance and the phone, fax or alarm. As shown in the diagram.

Installation process

- 1- Unplug the phone cable from the line output.
- 2- Connect the microfilter to the line output.
- 3- Connect the phone cable to the microfilter connector RJ11 (telephone).

It contains

- Microfilter MFAS101
- Adhesive tape
- Installation instructions.

The ADSL microfilter allows the transmission of the voice signal, (low pass band filter) and avoids the transmission of the ADSL signal to the phone or other equipment connected to the output. The voice signal keeps a high quality without distortions or noises.

The maximum number of microfilters that can be installed in the same line is 3, if higher an HR splitter must be used.

MFAD001 To be used in conventional lines (POTS) and without billing tone. It can be placed next to the telephone or at the line output.

Countries: Argentina, Brazil, Colombia, Costa Rica, Chile, Egypt, Spain, Estonia, Greece, India, Island, Italy, Japan, Luxemburg, Peru, Poland, Portugal, Rumania, South Africa, Turkey, Uruguay, U.S.A., Venezuela



- Ready for new ADSL 2 + technology.
- Plastic material (Fireproof).
- RJ11 connector with gold covering (50µ")
- Exclusive design
- Designed according environment regulation ETS300019 part.1-1, class1.2; part1-2, class2.3; part.1-3, class3.2

Technical requirements

Voice specifications		General specifications	
Pass band (P.b.)	0-4 KHz	Resistance in loop	< 50 Ω
Line impedance	600 Ω	Line/ground isolation resistance	> 100 M.Ω
Insertion losses in (B.p.)	< 0,32dB	Isolation resistance line	> 10 M.Ω
Distortion of insert losses in (B.p.)	< 0,5 dB	Line connectors	1 RJ11
Return losses to 200Hz : 1MFA - (3MFA)	> 10,2 dB – (>10,2DdB)	Phone connectors	1 RJ11
Return losses to 3,5KHz : 1MFA - (3MFA)	> 12 dB – (>10,5 dB)	Cable with two connectors RJ11 (length)	15 cm
Return losses to 4,4KHz : 1MFA - (3MFA)	> 14 dB – (>12,5 dB)	Surface mounting	Adhesive tape
ADSL band attenuation (32 KHz – 2,2 MHz)	> 20 dB	Dimensions	(59x27x23) mm
Maximum current (Imax) d.c.	100 mA	Weight	35 gr

Installation and connections

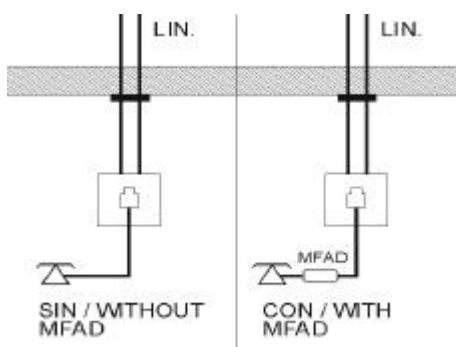

Installation diagram

The ADSL microfilter must be placed between the line entrance and the phone, fax or alarm. As shown in the diagram.

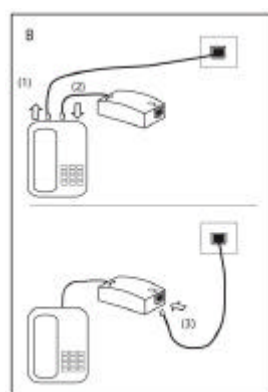

Installation process

- A/1- Unplug the phone cable from the line output.
 2- Connect the microfilter to the line output. (LIN).
 3- Connect the phone cable to the microfilter connector RJ11 (telephone).
 B/1- Unplug the phone line cable.
 2- Connect the microfilter to phone, with the supplied cable.
 3- Connect the line cable to the microfilter line (LIN)



It contains

- Microfilter MFAD001
- Cable 15cm with 2 connectors RJ11
- Adhesive tape
- Installation instructions

The ADSL microfilter allows the transmission of the voice signal, (low pass band filter) and avoids the transmission of the ADSL signal to the phone or other equipment connected to the output. The voice signal keeps a high quality without distortions or noises.

The maximum number of microfilters that can be installed in the same line is 3, if higher an HR splitter must be used.

MFAD101- To be used in conventional lines (POTS) and without billing tone. It can be placed next to the telephone or at the line output.

Countries: Australia, Belgium, Bulgaria, Canada, Cyprus, Holland, Ireland, Check Republic, Sweden, Tunes.



- Ready for new ADSL 2 + technology.
- Plastic material (Fireproof).
- RJ11 connector with gold covering (50µ")
- Exclusive design
- Designed according environment regulation ETS300019 part.1-1, class1.2; part1-2, class2.3; part.1-3, class3.2

Technical requirements

Voice specifications		General specifications	
Pass band (P.b.)	0-4 KHz	Resistance in loop	< 50 Ω
Line impedance	150nf // 750Ω + 270 Ω	Line/ground isolation resistance	> 100 Ω
Insertion losses in (B.p.)	< 0,32dB	Isolation resistance line	> 10 MΩ
Distortion of insert losses in (B.p.)	< 0,5 dB	Line connectors	1 RJ11
Return losses to 200Hz : 1MFA - (3MFA)	> 10,2 dB – (>10,2DdB)	Phone connectors	1 RJ11
Return losses to 3,5KHz : 1MFA - (3MFA)	> 12 dB – (>10,5 dB)	Cable with two connectors RJ11 (length)	15 cm
Return losses to 4,4KHz : 1MFA - (3MFA)	> 14 dB – (>12,5 dB)	Surface mounting	Adhesive tape
ADSL band attenuation (32 KHz – 2,2 MHz)	> 20 dB	Dimensions	(59x27x23) mm
Maximum current (Imax) d.c.	100 mA	Weight	35 gr

Installation and connections

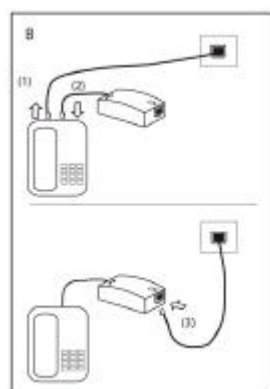
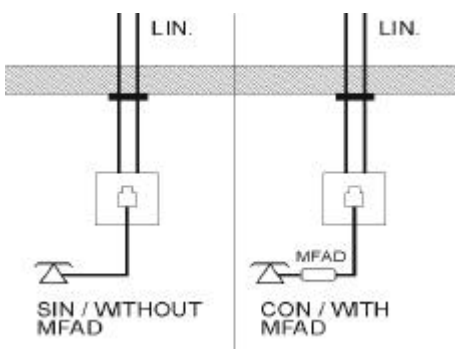

Installation diagram

The microfilter ADSL Alarm must be placed in the line entrance in the alarm equipment. As shown in the diagram.

Installation process

- A/1- Unplug the phone cable from the line output.
 2- Connect the microfilter to the line output.
 3- Connect the phone cable to the microfilter connector RJ11 (telephone).
- B/1- Unplug the phone line cable.
 2- Connect the microfilter to phone, with the supplied cable.
 3- Connect the line cable to the microfilter line (L1IN)

It contains

- Microfilter MFAD101
- Cable 15cm with 2 connectors RJ11
- Adhesive tape
- Installation Instructions

The ADSL microfilter allows the transmission of the voice signal, (low pass band filter) and avoids the transmission of the ADSL signal to the phone or other equipment connected to the output. The voice signal keeps a high quality without distortions or noises.

The maximum number of microfilters that can be installed in the same line is 3, if higher an HR splitter must be used.

MFAS001- To be used in conventional lines (POTS) and without billing tone. It is not necessary to use an auxiliary (T) RJ11.

Countries: Argentina, Brazil, Colombia, Costa Rica, Chile, Egypt, Spain, Estonia, Greece, India, Island, Italy, Japan, Luxemburg, Peru, Poland, Portugal, Rumania, South Africa, Turkey, Uruguay, U.S.A., Venezuela



- Ready for new ADSL 2 + technology.
- Plastic material (Fireproof).
- RJ11 connector with gold covering (50µ"m)
- Exclusive design
- Designed according environmental regulation ETS300019 part1-3, class3.2, class1.2 and part 1-2, class2.3

Technical requirements

Voice specifications		General specifications	
Pass band (P.b.)	0-4 KHz	Resistance in loop	< 50 Ω
Line impedance	600 Ω	Line/ground isolation resistance	> 100 M Ω
Insertion losses in (B.p.)	< 0,32dB	Isolation resistance line	> 10 M Ω
Distortion of insert losses in (B.p.)	< 0,5 dB	Line connectors (length 15 cm)	Cable with RJ11
Return losses to 200Hz : 1MFA - (3MFA)	> 10,2 dB - (>10,2DdB)	Phone connectors	1 RJ11
Return losses to 3,5KHz : 1MFA - (3MFA)	> 12 dB - (>10,5 dB)	ADSL data connectors	NO
Return losses to 4,4KHz : 1MFA - (3MFA)	> 14 dB - (>12,5 dB)	Surface mounting	Adhesive tape
ADSL band attenuation (32 KHz – 2,2 MHz)	> 20 dB	Dimensions	(59x27x23) mm
Maximum current (Imax) d.c.	100 mA	Weight	35 gr

Installation and connections

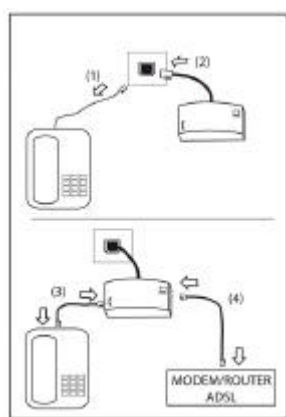
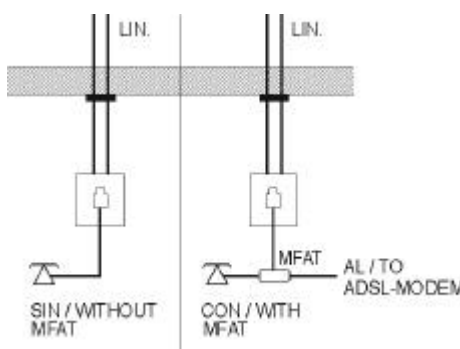

Installation diagram

The microfilter ADSL T must be placed in the line entrance where you wish to connect the MODEM or ADSL router. As shown in the diagram. With the T microfilter there is no need to use an auxiliary (T) RJ11.

Installation process

- 1- Unplug the phone cable from the line output.
- 2- Connect the microfilter MFAT to the line output.
- 3- Connect the telephone to the microfilter (telephone)
- 4- Connect the MODEM or router to the microfilter (Data)

It contains

- Microfilter MFAT001
- Adhesive tape
- Installation instructions

The ADSL microfilter allows the transmission of the voice signal, (low pass band filter) and avoids the transmission of the ADSL signal to the phone or other equipment connected to the output. The voice signal keeps a high quality without distortions or noises.

The maximum number of microfilters that can be installed in the same line is 3, if higher an HR splitter must be used.

MFAT101 - To be used in conventional lines (POTS) and without billing tone. It is not necessary to use an auxiliary (T) RJ11.

Countries: Australia, Belgium, Bulgaria, Canada, Cyprus, Holland, Ireland, Check Republic, Sweden, Tunes.



- Ready for new ADSL 2 + technology.
- Plastic material (Fireproof).
- RJ11 connector with gold covering (50µ"")
- Exclusive design
- Designed according environment regulation ETS300019 part.1-1, class1.2; part1-2, class2.3; part.1-3, class3.2

Technical requirements

Voice specifications		General specifications	
Pass band (P.b.)	0-4 KHz	Resistance in loop	< 50 Ω
Line impedance	150nf //750Ω + 270 Ω	Line/ground isolation resistance	> 100 MΩ
Insertion losses in (B.p.)	< 0,32dB	Isolation resistance line	> 10 MΩ
Distortion of insert losses in (B.p.)	< 0,5 dB	Line connectors	Cable 15cm with RJ11 connector
Return losses to 200Hz : 1MFA - (3MFA)	> 10,2 dB - (>10,2DdB)	Phone connectors	1 RJ11
Return losses to 3,5KHz : 1MFA - (3MFA)	> 12 dB - (>10,5 dB)	ADSL data connectors	1 RJ11
Return losses to 4,4KHz : 1MFA - (3MFA)	> 14 dB - (>12,5 dB)	Surface mounting	Adhesive tape
ADSL band attenuation (32 KHz – 2,2 MHz)	> 20 dB	Dimensions	(59x27x23) mm
Maximum current (Imax) d.c.	100 mA	Weight	35 gr

Installation and connections

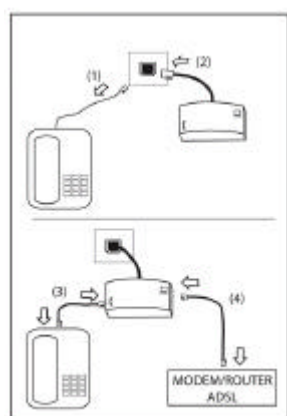
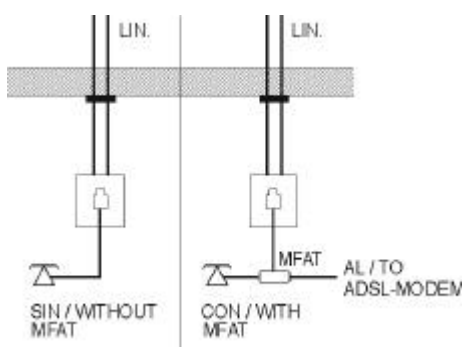

Installation diagram

The microfilter ADSL T must be placed in the line entrance where you wish to connect the MODEM or ADSL router. As shown in the diagram. With the T microfilter there is no need to use an auxiliary (T) RJ11.

Installation process

- 1- Unplug the phone cable from the line output.
- 2- Connect the microfilter MFAT to the line output.
- 3- Connect the telephone to the microfilter (telephone)
- 4- Connect the MODEM or router to the microfilter (Data)

It contains

- Microfilter MFAT101
- Adhesive tape
- Installation instructions

The ADSL microfilter alarm allows the transmission of the alarm signals, (low pass band filter) and avoids the transmission of the ADSL signal to the alarm equipment connected to the output, allowing its correct performance.

The maximum number of microfilters that can be installed in the same line is 3, if higher an HR splitter must be used.

MFAA001- To be used in conventional lines (POTS) and without billing tone.

Countries: Argentina, Brazil, Colombia, Costa Rica, Chile, Egypt, Spain, Estonia, Greece, India, Island, Italy, Japan, Luxemburg, Peru, Poland, Portugal, Rumania, South Africa, Turkey, Uruguay, U.S.A., Venezuela



- Ready for new ADSL 2 + technology
- Plastic material V.O. (Fireproof)
- Connector type clamp
- Exclusive design
- Designed according environment regulation ETS300019 part.1-1, class1.2; part1-2, class2.3; part.1-3, class3.2

Technical requirements

Voice specifications		General specifications	
Pass band (P.b.)	0-4 KHz	Resistance in loop	< 50 Ω
Line impedance	600 Ω	Line/ground isolation resistance	> 100 M.Ω
Insertion losses in (B.p.)	< 0,32dB	Isolation resistance line	> 10 M.Ω
Distortion of insert losses in (B.p.)	< 0,5 dB	Line connectors	Type clamp
Return losses to 200Hz : 1MFA - (3MFA)	> 10,2 dB - (>10,2DdB)	Phone connectors	Type clamp
Return losses to 3,5KHz : 1MFA - (3MFA)	> 12 dB - (>10,5 dB)	ADSL data connectors	NO
Return losses to 4,4KHz : 1MFA - (3MFA)	> 14 dB - (>12,5 dB)	Surface mounting	Adhesive tape
ADSL band attenuation (32 KHz - 2,2 MHz)	> 20 dB	Dimensions	(59x27x23) mm
Maximum current (Imax) d.c.	100 mA	Weight	35 gr

Installation and connections

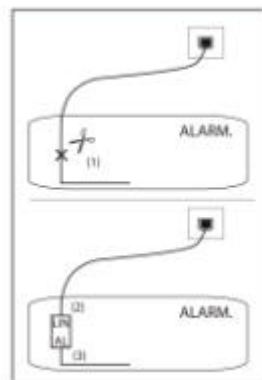
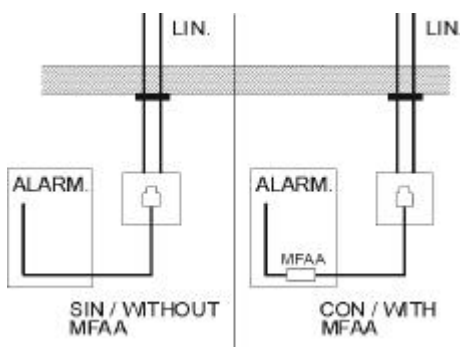

Installation diagram

The microfilter ADSL Alarm must be placed in the line entrance in the alarm equipment. As shown in the diagram.

Installation process

- 1- Get to the line entrance point in the alarm equipment., and cut the line cable.
- 2- Connect the line cable to the microfilter connectors (LIN).
- 3- Connect the other end of the cable to the microfilter connector (ALARM).

It contains

- Microfilter MFAA001
- Adhesive tape
- Installation instructions

The ADSL microfilter alarm allows the transmission of the alarm signals, (low pass band filter) and avoids the transmission of the ADSL signal to the alarm equipment connected to the output, allowing its correct performance.

The maximum number of microfilters that can be installed in the same line is 3, if higher an HR splitter must be used.



MFAA101- To be used in conventional lines (POTS) and without billing tone.

- Ready for new ADSL 2 + technology
- Plastic material V.O. (Fireproof)
- Connector type clamp
- Exclusive design
- Designed according environment regulation ETS300019 part.1-1, class1.2; part1-2, class2.3; part.1-3, class3.2

Countries: Australia, Belgium, Bulgaria, Canada, Cyprus, Holland, Ireland, Check Republic, Sweden, Tunes.

Technical requirements

Voice specifications		General specifications	
Pass band (P.b.)	0-4 KHz	Resistance in loop	< 50 Ω
Line impedance	150nf // 750Ω + 270 Ω	Line/ground isolation resistance	> 100 M.Ω
Insertion losses in (B.p.)	< 0,32dB	Isolation resistance line	> 10 M.Ω
Distortion of insert losses in (B.p.)	< 0,5 dB	Line connectors	Type clamp
Return losses to 200Hz : 1MFA - (3MFA)	> 10,2 dB – (>10,2DdB)	Phone connectors	Type clamp
Return losses to 3,5KHz : 1MFA - (3MFA)	> 12 dB – (>10,5 dB)	ADSL data connectors	NO
Return losses to 4,4KHz : 1MFA - (3MFA)	> 14 dB – (>12,5 dB)	Surface mounting	Adhesive tape
ADSL band attenuation (32 KHz – 2,2 MHz)	> 20 dB	Dimensions	(59x27x23) mm
Maximum current (Imax) d.c.	100 mA	Weight	35 gr

Installation and connections

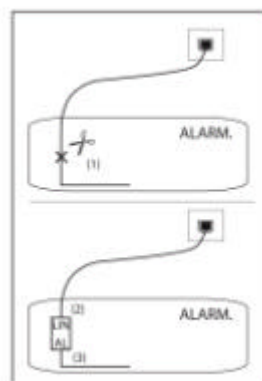
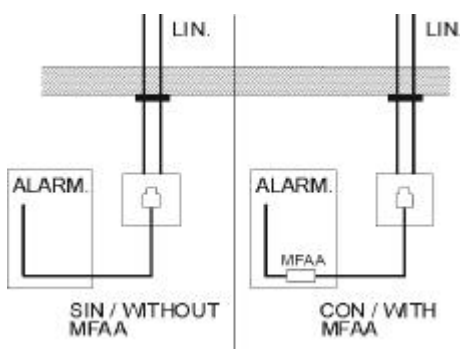

Installation diagram

The microfilter ADSL Alarm must be placed in the line entrance in the alarm equipment. As shown in the diagram.

Installation process

- 1- Get to the line entrance point in the alarm equipment., and cut the line cable.
- 2- Connect the line cable to the microfilter connectors (LIN).
- 3- Connect the other end of the cable to the microfilter connector (ALARM).

It contains

- Microfilter MFAA101
- Adhesive tape
- Installation instructions

The AM filter avoids the radio electrical interferences from the telephone line cables due to the AM radio commercial emissions.

The AM filter must be placed in the telephone line near the phone affected by these interferences.

FAM001- To be used in conventional lines (POTS)

Countries: All countries.



- Plastic material (Fireproof).
- Connector type screw de 2 y 3 vias
- Exclusive design
- It goes through corrosion tests as per regulation UNE20501 ap. 2.11
- Designed according environmental regulation ETS300019 part1-3, class3.2, class1.2 and part 1-2, class2.3

Technical requirements

Voice specifications		General specifications	
Pass band (P.b.)	400 KHz – 1600 KHz	Resistance in loop	< 50 Ω
Line impedance	600 Ω	Line/ground isolation resistance	> 100 M Ω
Insertion losses (400KHz – 1600 KHz)	< 0,5dB	Isolation resistance line	> 10 M Ω
Insertion losses 12KHz	< 1 dB	Line capacity	15 nf
Transformer loses	< 1 dB	Line connectors	Screw type 3 vias
Insertion losses in comon way	Ganancia < -50dB (400KHz – 1600KHz)	Phone connectors	Screw type 2 vias
Insertion losses (100KHz – 400KHz)	> 10 dB	Surface mounting	Adhesive tape
ADSL band attenuation (32 KHz – 2,2 MHz)	> 20 dB	Dimensions	(59x27x23) mm
Maximum current (Imax) d.c.	100 mA	Weight	35 gr

Installation and connections

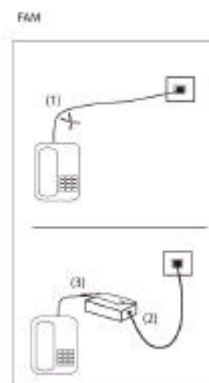
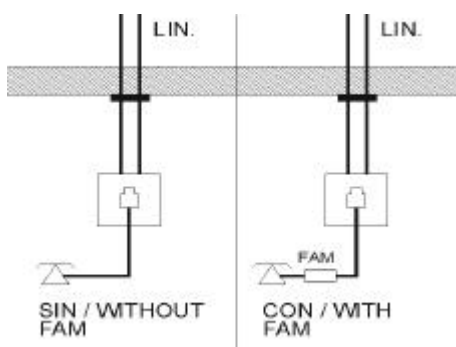

Installation diagram

The AM filter must be placed between the line entrance point and the telephone as shown in above diagram.

Installation process

- 1- Cut the line cable somewhere near the telephone.
- 2- Connect the line cable to the AM filter connectors (LIN).
- 3- Connect the other side of the cable to the telephone connector (TELEPHONE) from the AM filter.

It contains

- Filter FAM001
- Adhesive tape
- Installation instructions